

Evolution MkIV and High Flow Rough In Slimline and Modline Tank

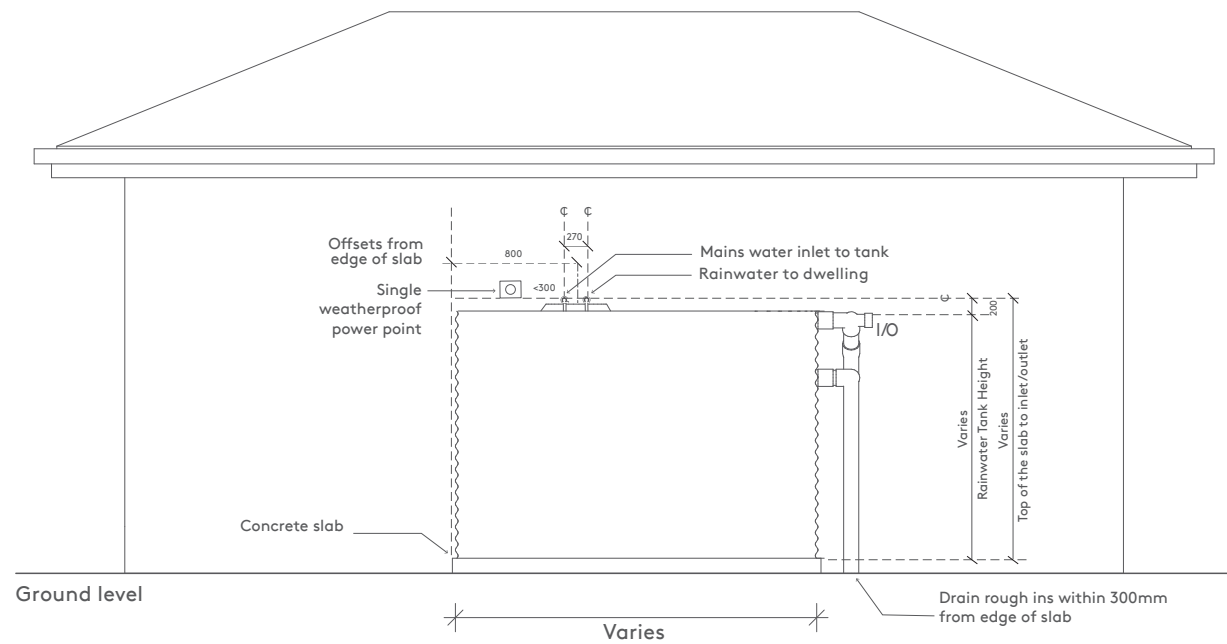

FRONT ELEVATION OPTION A

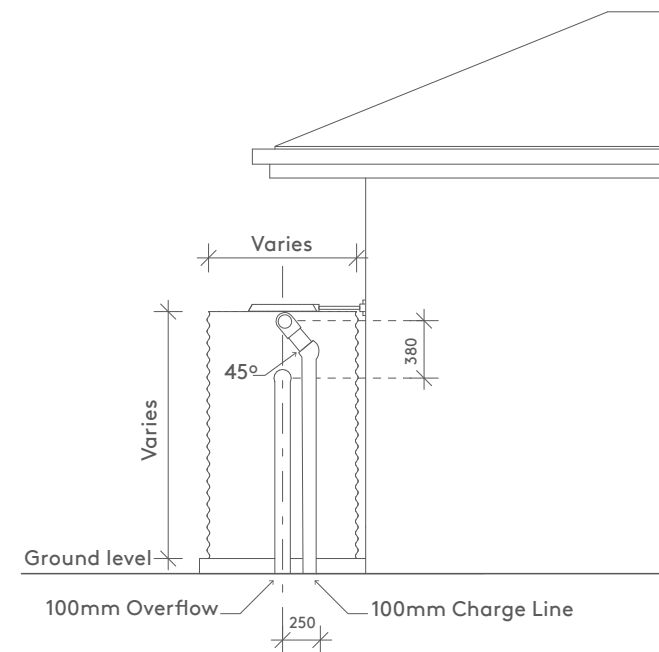

SIDE ELEVATION TYPICAL

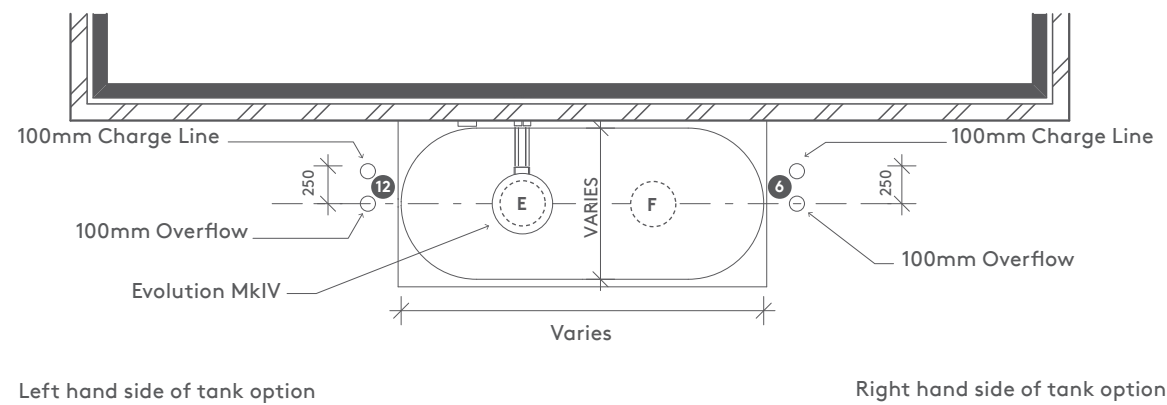

PLAN VIEW TYPICAL

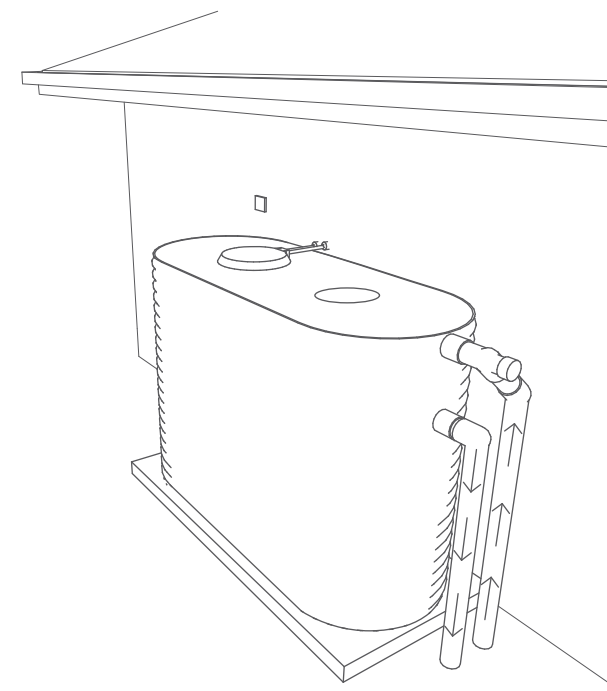

PERSPECTIVE VIEW

UNLESS SPECIFIED

Evolution MkIV default position is **E**
 High Flow default position is **6**
 25mm drain outlet default position is **12**

We take every care to ensure that the information in this document is accurate at the point of publication. Information should not be taken as binding. To ensure you are viewing the most up to date information, please visit: <https://kingspanwatertanks.com.au/evolution-mkiv-rough-in-guides>

©Kingspan and the Lion Device are Registered Trademarks of the Kingspan Group. All rights reserved. Registered Office: Kingspan Water & Energy Pty Limited, 3 Herbert Place, Smithfield, NSW 2164

Our Locations

SYDNEY
 3 Herbert Place
 Smithfield NSW 2164

DENILQUIN WAREHOUSE/DEPOT
 Lot 22 Wakool Road
 Deniliquin NSW 2710

MELBOURNE
 55 Ricky Way
 Epping VIC 3076

BRISBANE
 Unit 2/59 Link Drive
 Yatala QLD 4207

PERTH
 54 Collopy Road
 Perth Airport WA 6105

1300 736 562
kingspanwatertanks.com.au
sales.au@kingspan.com



Evolution MkIV and High Flow Rough In Round Water Tank

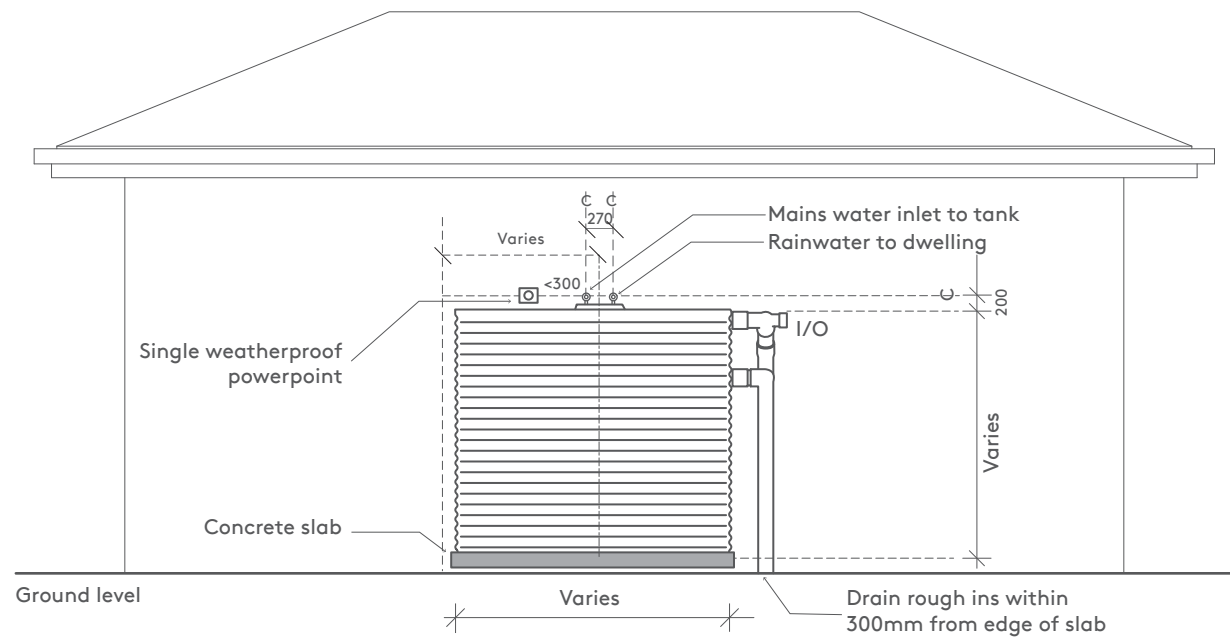

FRONT ELEVATION OPTION A

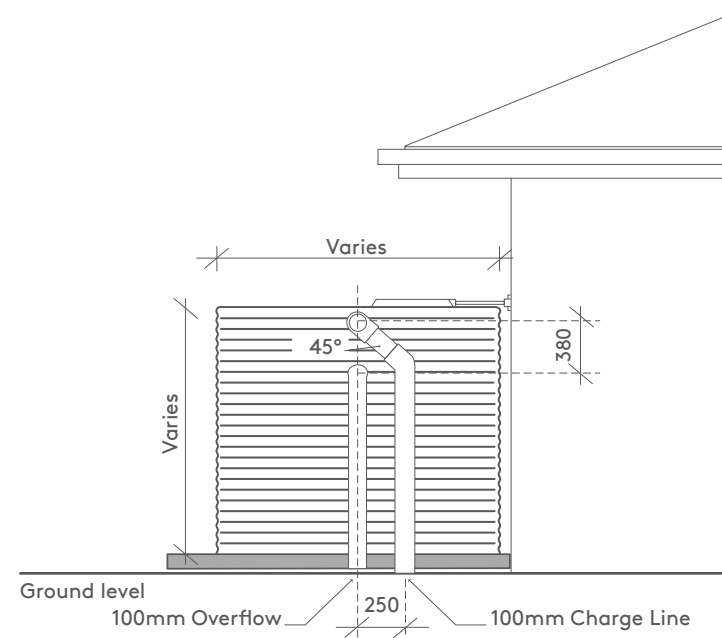

SIDE ELEVATION TYPICAL

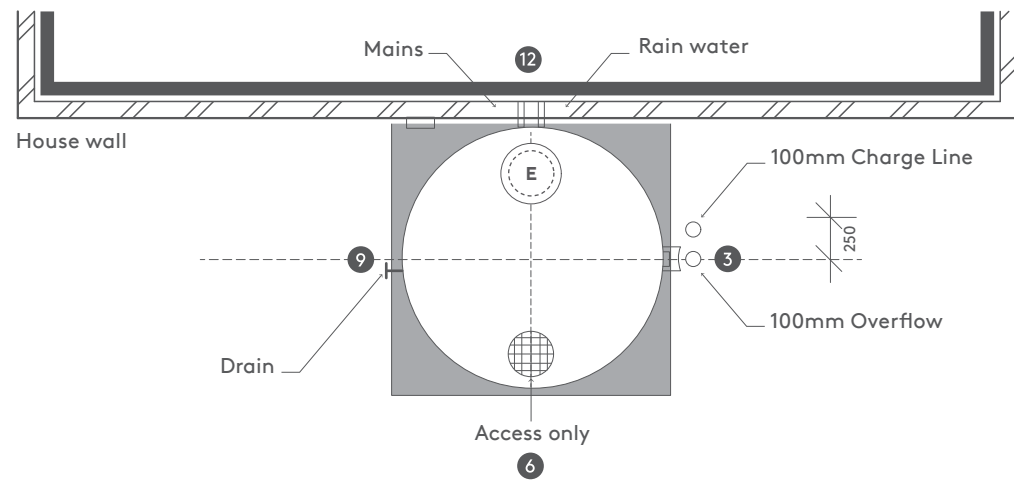

PLAN VIEW TYPICAL

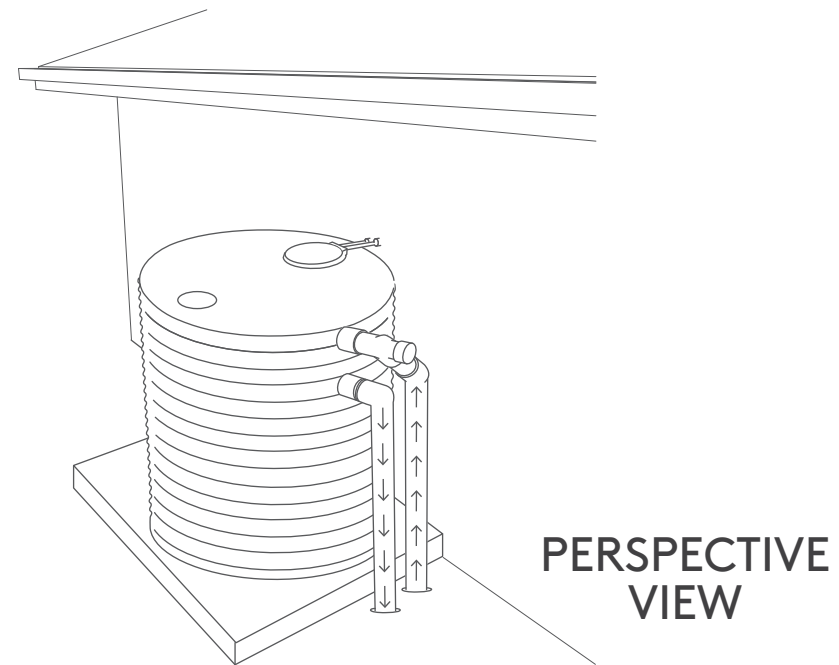

PERSPECTIVE VIEW

UNLESS SPECIFIED

Evolution MkIV default position is 12
High Flow default position is 3

We take every care to ensure that the information in this document is accurate at the point of publication. Information should not be taken as binding. To ensure you are viewing the most up to date information, please visit: <https://kingspanwatertanks.com.au/evolution-mkiv-rough-in-guides>

©Kingspan and the Lion Device are Registered Trademarks of the Kingspan Group. All rights reserved. Registered Office: Kingspan Water & Energy Pty Limited, 3 Herbert Place, Smithfield, NSW 2164

Our Locations

SYDNEY
3 Herbert Place
Smithfield NSW 2164

DENILQUIN WAREHOUSE/DEPOT
Lot 22 Wakool Road
Deniliquin NSW 2710

MELBOURNE
55 Ricky Way
Epping VIC 3076

BRISBANE
Unit 2/59 Link Drive
Yatala QLD 4207

PERTH
54 Collopy Road
Perth Airport WA 6105

1300 736 562
kingspanwatertanks.com.au
sales.au@kingspan.com



Evolution MkIV

Rough In guide for Dual Charge Line Slimline and Modline Tanks

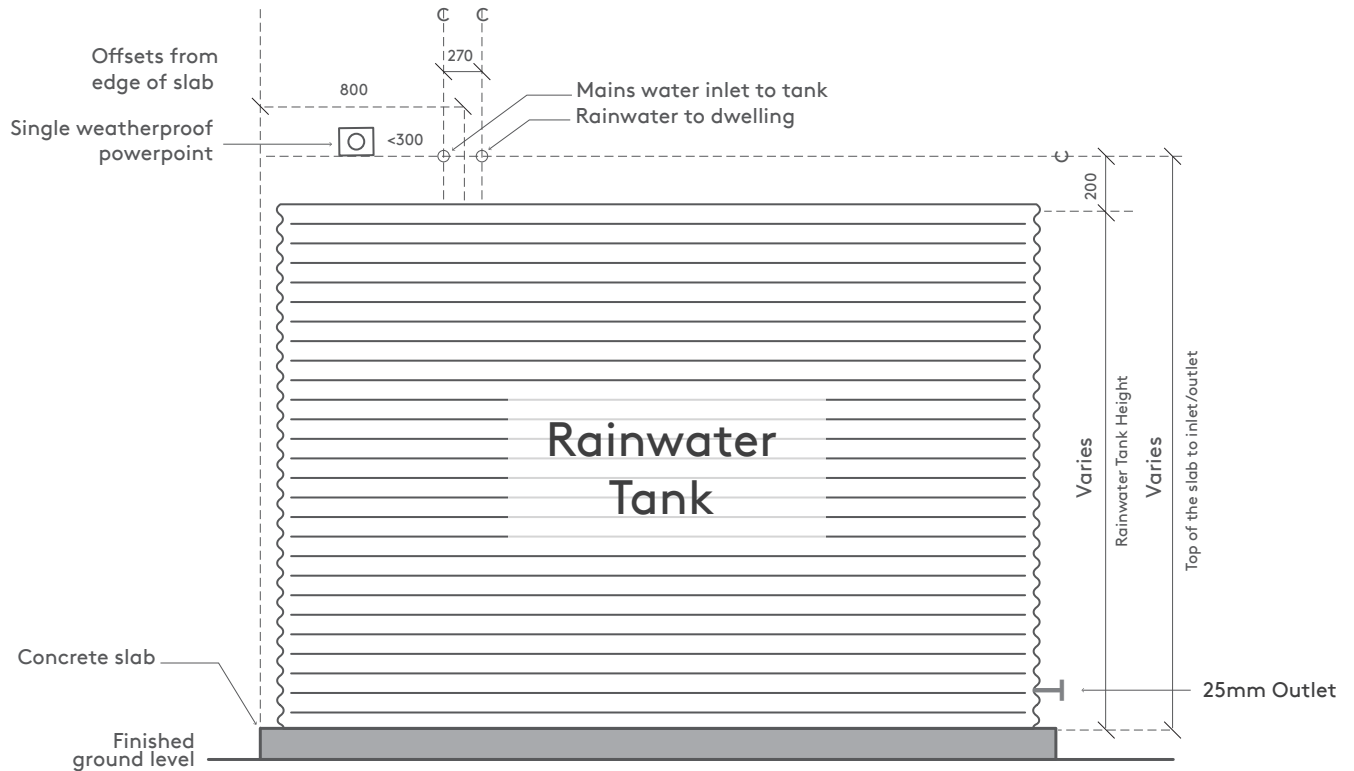

FRONT ELEVATION

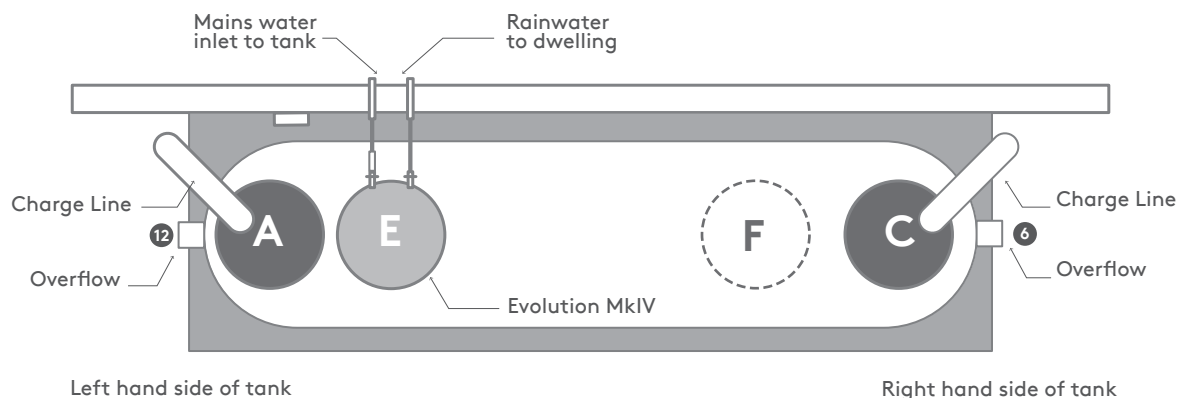

PLAN VIEW TYPICAL

UNLESS SPECIFIED

Evolution MkIV default position is **E**
25mm drain outlet default position is **6**

Our Locations

SYDNEY

3 Herbert Place
Smithfield NSW 2164

DENILQUIN WAREHOUSE/ DEPOT

Lot 22 Wakool Road
Deniliquin NSW 2710

MELBOURNE

55 Ricky Way
Epping VIC 3076

BRISBANE

Unit 2/59 Link Drive
Yatala QLD 4207

PERTH

54 Collopy Road
Perth Airport WA 6105

1300 736 562

kingspanwatertanks.com.au
sales.au@kingspan.com



We take every care to ensure that the information in this document is accurate at the point of publication. Information should not be taken as binding. To ensure you are viewing the most up to date information, please visit: <https://kingspanwatertanks.com.au/evolution-mkiv-rough-in-guides>
©Kingspan and the Lion Device are Registered Trademarks of the Kingspan Group. All rights reserved.
Registered Office: Kingspan Water & Energy Pty Limited, 3 Herbert Place, Smithfield, NSW 2164

Evolution MkIV

Rough In guide for Dual Charge Line Round Tanks

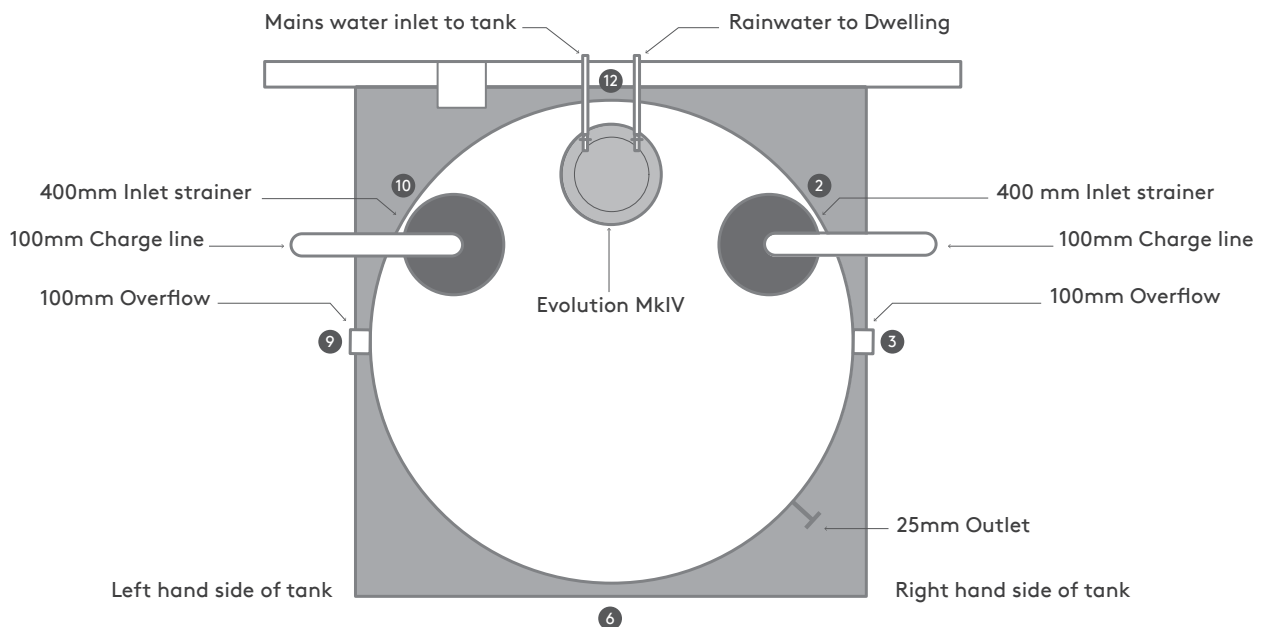
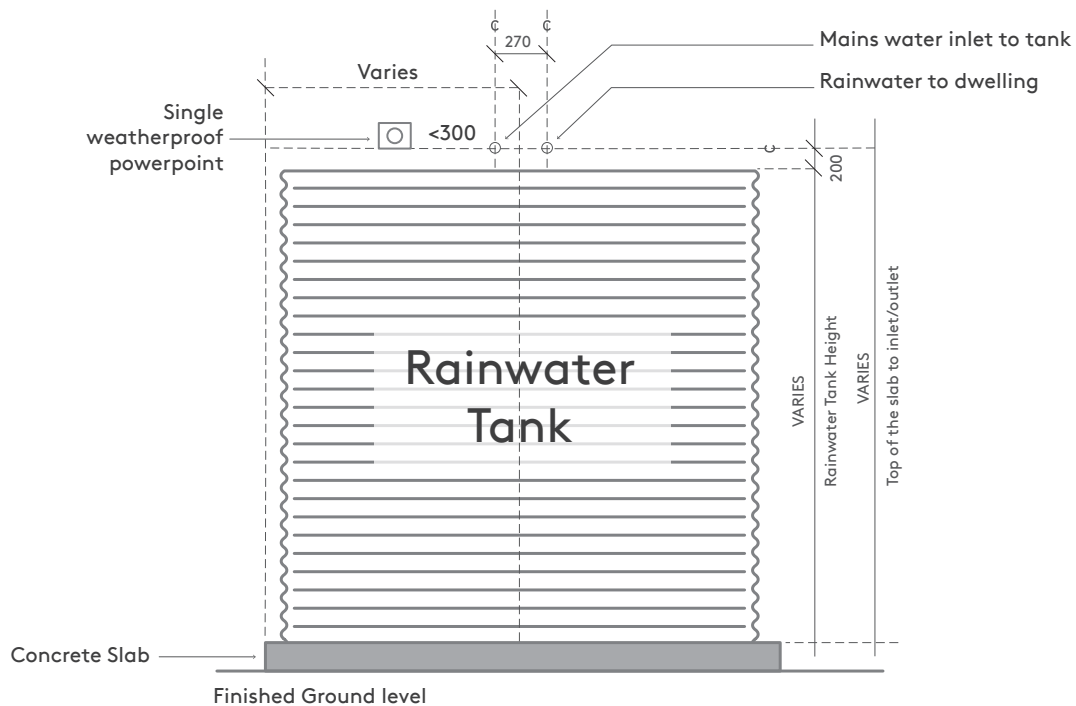

Our Locations

SYDNEY
3 Herbert Place
Smithfield NSW 2164

**DENILQUIN WAREHOUSE/
DEPOT**
Lot 22 Wakool Road
Deniliquin NSW 2710

MELBOURNE
55 Ricky Way
Epping VIC 3076

BRISBANE
Unit 2/59 Link Drive
Yatala QLD 4207

PERTH
54 Collopy Road
Perth Airport WA 6105

1300 736 562
kingspanwatertanks.com.au
sales.au@kingspan.com



We take every care to ensure that the information in this document is accurate at the point of publication. Information should not be taken as binding. To ensure you are viewing the most up to date information, please visit: <https://kingspanwatertanks.com.au/evolution-mkiv-rough-in-guides>
©Kingspan and the Lion Device are Registered Trademarks of the Kingspan Group. All rights reserved.
Registered Office: Kingspan Water & Energy Pty Limited, 3 Herbert Place, Smithfield, NSW 2164

Evolution MkIV

Away from house Rough In diagram

LEFT SIDE ELEVATION

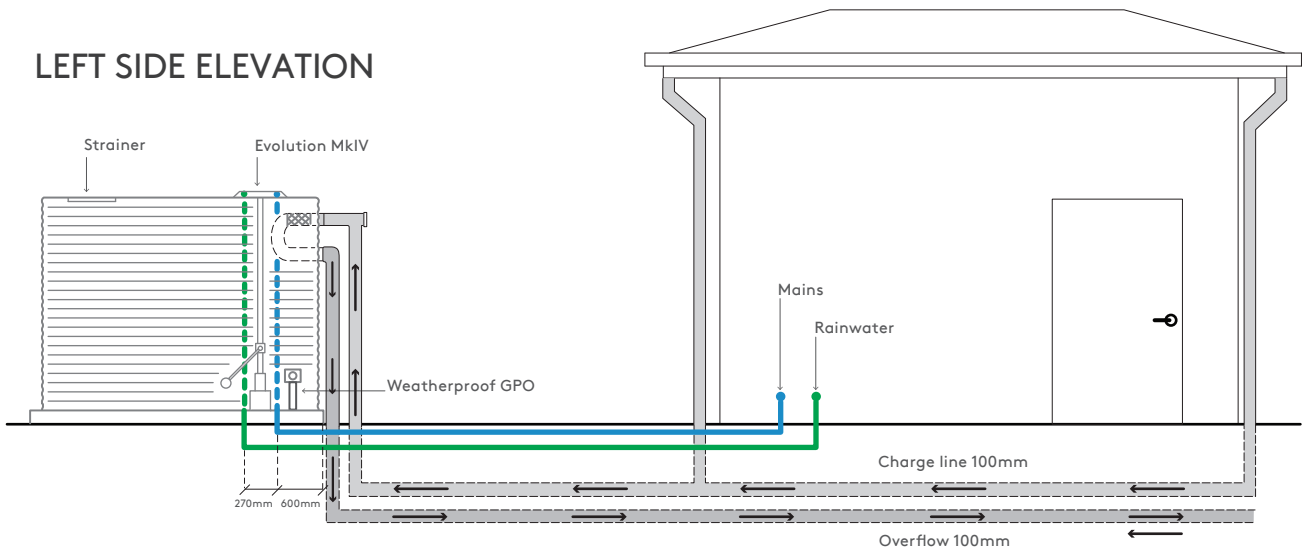

PLAN VIEW - LEFT HAND SIDE FROM THE STREET

PLAN VIEW - RIGHT HAND SIDE FROM THE STREET

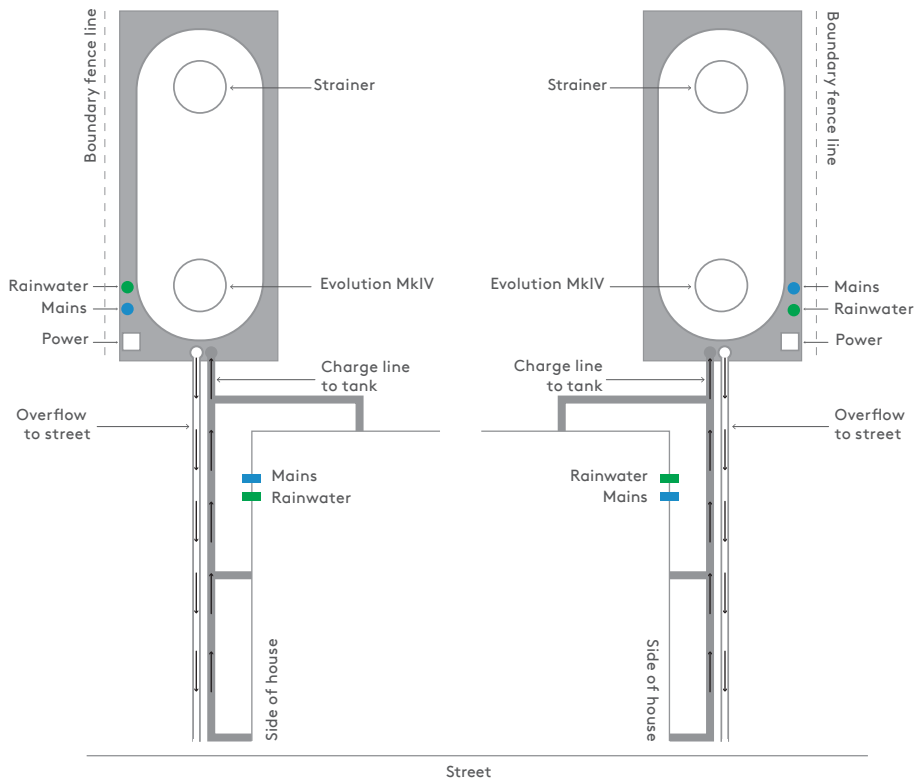

Our Locations

SYDNEY
3 Herbert Place
Smithfield NSW 2164

**DENILQUIN WAREHOUSE/
DEPOT**
Lot 22 Wakool Road
Deniliquin NSW 2710

MELBOURNE
55 Ricky Way
Epping VIC 3076

BRISBANE
Unit 2/59 Link Drive
Yatala QLD 4207

PERTH
54 Collopy Road
Perth Airport WA 6105

1300 736 562
kingspanwatertanks.com.au
sales.au@kingspan.com



We take every care to ensure that the information in this document is accurate at the point of publication. Information should not be taken as binding. To ensure you are viewing the most up to date information, please visit: <https://kingspanwatertanks.com.au/evolution-mkiv-rough-in-guides>
©Kingspan and the Lion Device are Registered Trademarks of the Kingspan Group. All rights reserved.
Registered Office: Kingspan Water & Energy Pty Limited, 3 Herbert Place, Smithfield, NSW 2164